Masters Theses

Student Theses and Dissertations

Fall 2009

Analogy based modeling of natural convection

Vaibhav Khane

Follow this and additional works at: https://scholarsmine.mst.edu/masters_theses

 Part of the [Nuclear Engineering Commons](#)

Department:

Recommended Citation

Khane, Vaibhav, "Analogy based modeling of natural convection" (2009). *Masters Theses*. 4723.
https://scholarsmine.mst.edu/masters_theses/4723

This thesis is brought to you by Scholars' Mine, a service of the Curtis Laws Wilson Library at Missouri University of Science and Technology. This work is protected by U. S. Copyright Law. Unauthorized use including reproduction for redistribution requires the permission of the copyright holder. For more information, please contact scholarsmine@mst.edu.

ANALOGY BASED MODELING
OF
NATURAL CONVECTION

by

VAIBHAV B. KHANE

A THESIS

Presented to the Faculty of the Graduate School of the
MISSOURI UNIVERSITY OF SCIENCE AND TECHNOLOGY

In Partial Fulfillment of the Requirements for the Degree

MASTER OF SCIENCE IN NUCLEAR ENGINEERING

2009

Approved by

Shoaib Usman, Advisor
Gary E. Mueller
Carlos Castano
Arvind Kumar, Program Chair

PUBLICATION THESIS OPTION

This thesis consists of the journal article that has been accepted for publication on 14th Oct. 2009, by Nuclear Engineering and Design Journal. Pages 1-24 of this thesis have been prepared in the style utilized by the Nuclear Engineering and Design Journal.

ABSTRACT

This research is an extension of previous work on the development of an integrator or resistance-capacitance circuit analogy for natural convection. As a part of a larger project to enhance transport phenomenon on a micro-scale using radiation, this work studied the phenomenon of natural convection. Using experimental techniques and numerical simulations (FLUENT code), it investigated the transient response of a natural convection system. It proposes an integrator circuit analogy for a natural convection system. Experimental investigation with three different fluids indicated that the characteristic time constant of the system is related to the Prandtl number of the fluid. The project also investigated the effect of gravity and fluid viscosity.

Previous simulation results suggested that a natural convection system acts as a low pass filter. Transmission characteristics of a natural convection system were found to be a function of both fluid properties and flow characteristics. The transmission factor was found to be a strong function of frequency of temperature fluctuation.

This research carried out further numerical simulations which suggest that in addition to the thermal energy stored in the system, a natural convection system stores kinetic energy. This energy is related to the system's Rayleigh number. This additional kinetic-energy based capacitance should be considered when modeling the natural convection phenomena (particularly those involving fluids with low Prandtl numbers e.g., liquid metal coolant). Due to the coupling between the flow field and the temperature field, natural convection has variable thermal resistance, a condition analogous to voltage-dependent resistors in electric circuits. Numerical simulations observed this variable behavior of thermal resistance. Based on the results, this work proposes a new equivalent RC circuit representation for natural convection, a significant step towards development of a new computationally less intensive modeling and analysis tool for natural convection phenomena.

ACKNOWLEDGMENTS

I wish to express my heartfelt gratitude and deep appreciation to Dr. Shoaib Usman, my advisor, who guided me diligently and patiently through my thesis. He has been extremely helpful throughout and a constant source of motivation. I have learned a great deal from him.

I would also like to thank my committee members, Dr. Gary Mueller and Dr. Carlos H. Castano, for their support and cooperation. Special thanks to Mrs. Sheila Johnson and to Ms. Roberta Cox for their invaluable help at various stages of my masters program and with my thesis. I would also like to thank to Dr. Arvind Kumar, Program Chair, Nuclear Engineering Program for his support, the staff of the Curtis Law Wilson library and IT helpdesk for their support, help, and encouragement.

I would like to thank to the staff of the Missouri S&T nuclear reactor especially Mr. William Bonzer, Reactor Manager. I would like to thank to all my friends for always being there for me and for making my studies at Missouri S&T memorable.

Most importantly, I would like to thank my parents, my elder brother Sachin and his family for everything they have done for me; without them none of this would have been possible.

TABLE OF CONTENT

PUBLICATION THESIS OPTION.....	iii
ABSTRACT.....	iv
ACKNOWLEDGEMENTS.....	v
LIST OF ILLUSTRATIONS.....	vii
LIST OF TABLES.....	viii
PAPER	
1. Further on Integrator Circuit Analogy for Natural Convection.....	1
Abstract.....	1
1. Introduction.....	2
2. Simulation Set-up.....	10
3. Variable Thermal Resistance for Natural Convection.....	12
3-a. Simulation Boundary Conditions.....	12
3-b. Simulation Results Analysis.....	13
4. KINETIC Energy Capacitance.....	16
4-a. Simulation Boundary Conditions.....	17
4-b. Kinetic Energy Finding Technique.....	17
5. Conclusion.....	20
NOMENCLATURE.....	22
REFERENCES.....	23
VITA.....	25

LIST OF ILLUSTRATIONS

Fig. 1.	Equivalent RC Circuit for Natural Convection.....	7
Fig. 2.	Energy Flow Paths and Exchange Mechanisms for Natural Convection System.....	8
Fig. 3.	Heat Flux Variation with respect to ΔT	14
Fig. 4.	Thermal Resistance Variation with Temperature Difference (ΔT).....	15
Fig. 5.	Thermal Resistance Variation with Rayleigh number.....	16
Fig. 6.	Heat Flux Variation during Transient.....	18
Fig. 7.	Variation in Kinetic Energy Stored with Rayleigh Number.....	19

LIST OF TABLES

Table 1 Analytical tools available for Heat Transfer.....	3
---	---

Further on Integrator Circuit Analogy for Natural Convection

Vaibhav Khane and Shoaib Usman¹

Abstract

This research is an extension of previous work on the development of an integrator or resistance-capacitance circuit analogy for natural convection. This analogy has been proved experimentally and by numerical simulations. This work performed additional Rayleigh-Bénard convection numerical simulations to investigate the dependence of the thermal resistance of a natural convection system on the temperature difference between source and sink. (ΔT). The results confirm this dependence and demonstrate that it is analogous to voltage-dependent resistor in electrical engineering. This analogy implies that this dependence creates a variable time constant in natural convection systems. This research also suggests that a natural convection system, stores not only thermal energy but also kinetic energy. The relative contribution of kinetic energy capacitance depends on the systems Rayleigh number. The results of this study represent a significant step toward development of a new, inexpensive modeling and transient analysis tool for a natural convection system.

Key Words: *Rayleigh-Bénard Convection, Transient Natural Convection, Circuit Analogy, Kinetic Energy Capacitance.*

¹ Corresponding Author: Shoaib Usman, Associate Professor of Nuclear Engineering, Missouri University of Science and Technology, 225 Fulton Hall, 300 W. 13th St., Rolla, MO-65409; Phone: (573) 341-4745; Fax: 573-341-6309; email: usmans@mst.edu

1. Introduction

Many next-generations nuclear reactor systems depend on natural convection for their passive safety and normal operations (Sinha and Kakodkar, 2006; Sienicki and Moisseytsev, 2005). Even the current fleet of reactors relies heavily on natural convection for cool down and decay heat removal (Aqrawal and Guppy, 1981; Duffey and Hedges, 1999). For these reasons, natural convection has been an area of significant interest for nuclear engineering professionals. Consequently, the reliability of natural convection systems is emerging as an important area of study (Mackay, Apostolakis, and Hejzlar 2008). Numerous numerical tools are available for the thermo-fluid analysis of reactor systems (INEEL, 2001; FLUENT Version 6.2.16; Scheuerer et. al. 2005). However, all put a high demand on computer resources, thus limiting the number of analyses possible over a specific time. Therefore, tools are needed to permit quick modeling and analysis of numerous safety analysis scenarios and to evaluate design options for first approximation calculations.

To enable quick modeling, modeling tools are particularly crucial for analysis of various modes of heat transfer. Table 1 shows no analytical tool is currently available for transient analysis of convective heat transfer.

Table 1. Analytical tools available for Heat Transfer

	Conductive heat transfer	Convective heat transfer
Steady-state modeling Only resistors are needed in the equivalent circuits	$R_{cond} = \frac{\Delta x_{medium}}{A_{medium} k_{medium}}$	$R_{conv} = \frac{1}{A h_{convection}}$
Transient lumped modeling Resistors and capacitors are needed for modeling this system	$R_{cond} = \frac{\Delta x_{medium}}{A_{medium} k_{medium}}$ $C_{cond} = C_{th} \rho V$	Not available- Subject of this work

Based on the fundamental similarity between the flow of heat and electrical charge in a noninductive electrical circuit, useful analogy developed for steady state conductive heat transfer. This analogy has been extended for transient analysis by adding capacitors to the equivalent circuit to incorporate the system's thermal inertia (Paschkis and Baker, 1942). According to this analogy, instantaneous temperature differences and instantaneous heat transfer rates correspond to instantaneous voltage differences and currents in an equivalent electrical circuit. This extension made possible transient analysis of conduction. In the case of pure conduction, the resistance, R , is equal to the thermal resistance of the material layer, which is a function of thermal conductivity and geometrical parameters. The capacitance, C , is the thermal capacity of the material. Therefore the characteristic time constant of the system can be expressed as; $\tau = R.C$. For pure conduction, the time constant depends only on the physical properties of the material or fluid and on the geometry of the heat transfer system. Therefore, the time constant of an equivalent RC circuit for conduction is proportional to thermal diffusivity of the material (Rohsenow and Hartnett 1973). This simplified modeling scheme is commonly referred to as the lumped model. Once the time constant of the lumped

system is determined, standard tools from the electrical domain can be used to analyze a complex circuit of pure conduction components.

Chin, Nordlund, and Staton (2003) performed a comparative analysis of the conductive lumped model using finite element analysis technique with the goal of identifying the strengths and weaknesses of each of these tools. They used Motor-CAD (Staton 2000), a lumped heat transfer modeling tool, to investigate the thermal aspects of electric motor design and compare their findings with the finite element approach (FEMLAB 2002). Motor-CAD represents complex thermal problems by transforming the thermal network to an analogous electric network. For steady-state analysis, resistors alone were sufficient whereas capacitors based on the material's heat capacity were added to the network to represent system's thermal inertia. Chin's group concluded that calculation speed is a major advantage of an approach based on the lumped model. On the other hand, an approach based on finite element modeling (FEM) has the flexibility to model complex geometries and provide much detailed information about temperature distribution within the system at the expense of long execution time.

Subsequently, Chin and Staton (2004) applied these techniques to transient thermal analysis of permanent magnet traction motors. Their findings suggest that the lumped model is particularly well suited for that purpose. Thus, they recommend the use of a lumped analytical model for initial design optimization and analysis of hypothetical scenarios. While FEM based approach provided more detailed temperature distribution throughout a thermally conductive system and is more suitable, therefore, for later design stages and for fine tuning the geometry of steady-state conditions. It is important

to note, however, that the application of lumped analytical models is limited to pure conduction systems.

For convective heat transfer problems the analogy can be extended by redefining the thermal resistance of the equivalent circuit in terms of the convective heat transfer coefficient and thus making possible the steady state analysis of convection and conduction-convection combinations. However, for convective systems, the definition of capacitance is not clear; therefore, no transient analysis of such systems is possible. The purpose of the on-going research reported here is to extend the circuit analogy for convective systems, permitting transient analysis for combination conduction-convection systems. Such a tool would be valuable for a quick, first-approximation calculations of numerous engineering problems.

Rayleigh-Bénard (Bejan, A., 2004) and Bénard-Marangoni (Bau H, 1999) convection are classical experiments to investigate the fundamental nature of the phenomenon of natural convection. The experimental apparatus for Rayleigh-Bénard convection consists of two sufficiently wide parallel plates separated by a fluid of known thickness that is heated from below (source side). The onset of convection occurs when the Rayleigh number (Ra) exceeds the critical value of 1708. The Rayleigh number is an important dimensionless number characteristic of natural convection phenomena (Bejan, A., 2004) which is defined as:

$$Ra = \frac{g \beta \Delta T L^3 \rho}{\mu \alpha} \quad (1)$$

A previous experimental investigation of Rayleigh-Bénard convection (Usman et al., 2007a) confirmed that the temporal response of a convection system is similar to that

of an integrator circuit. This conclusion led to an extension of the RC circuit analogy for natural convection. The results were further validated by numerical simulations (Usman et al., 2007b), demonstrating that natural convection systems imitate all aspects of RC behavior. The simulations demonstrated that a natural convection system behaves as a low-pass filter, that is, it filters out high-frequency temperature fluctuations at the source side. Moreover, they showed that transmission of these fluctuations is a strong function of the frequency of periodic fluctuations. These results are entirely consistent with the analogous electrical circuit.

The present numerical study extends the concept of the analogous circuit to represent natural convection by an equivalent RC circuit, as shown in the figure 1. However, the resistance and capacitance of a natural convection system would be significantly different from those of a pure conduction system. Figure 1 shows the corresponding resistance as a combination of two parallel resistances. The fixed resistance is due to conduction, whereas the variable resistance is due to convection, which depends on the state of flow. Likewise, the revised circuit displays an additional capacitor parallel to the capacitor of a simple RC circuit. In the case of natural convection, some portion of the thermal energy supplied to the system is stored in form of kinetic energy in the fluid that is set in motion by natural convection. This additional kinetic energy capacitance must be properly modeled for accurate representation of natural convection, but it has not yet been studied.

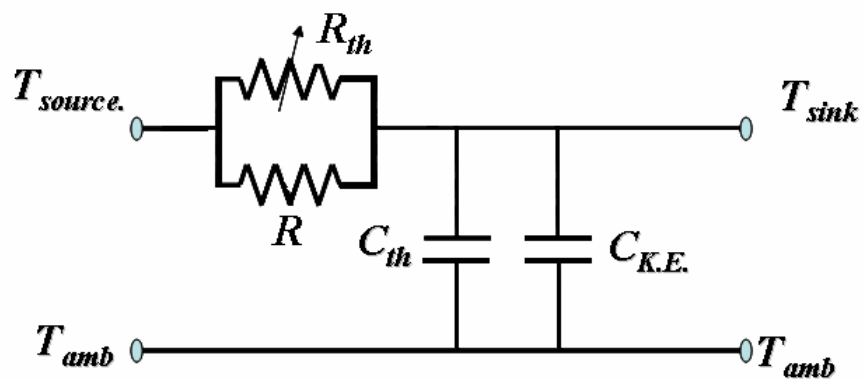

Fig.1 Equivalent RC Circuit for Natural Convection

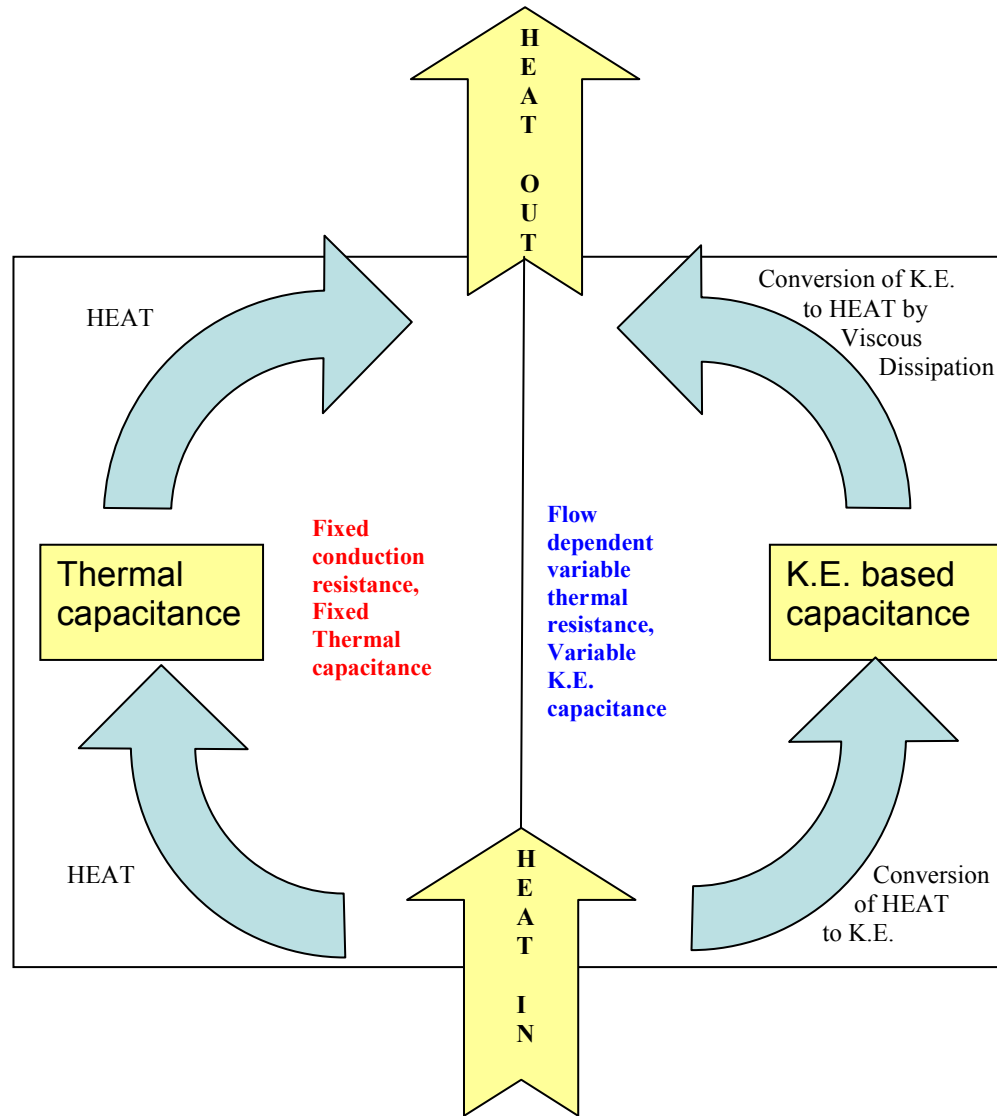

Fig. 2 Energy Flow Paths and Exchange Mechanisms for Natural Convection System

Figure 2 illustrates the flow of energy and the exchange of thermal energy with kinetic energy and vice versa for a natural convection system. The left side of the picture represents the conduction path available for the heat to pass through the system. This is the only path before the on-set of convection. This path offers a resistance that depends only on the thermal conductivity of the fluid and the geometric parameters. Likewise, the thermal capacitance depends only on the mass of the fluid and its specific heat. After the

on-set of convection a second convection path becomes available for the heat to flow through the system. This convective resistance depends heavily on the flow conditions in the system and is therefore represented as a variable resistance in figure 1. Heat is converted to fluid's K.E. and subsequently converted back to heat via viscous dissipation. For a steady state, these conversions are in equilibrium. For a transient state, the inequilibrium depends on the fluid properties (i.e., viscosity, density, thermal expansion coefficient etc.) and the system geometry. Therefore, an additional means of energy storage in the form of the kinetic energy of the fluid also becomes available to the system. This kinetic energy is dependent on the flow conditions. One aim of the present study is to investigate the relative significance of these various energy flow paths and capacitances.

Natural convection has long been known to exhibit nonlinear behavior because of close coupling between the flow field and the temperature field (Bejan, A., 2004). Thus, the heat transfer coefficient is a function of the temperature difference between source and sink (ΔT) and of fluid properties and geometrical parameters. Since thermal resistance is inversely proportional to the heat transfer coefficient, thermal resistance becomes a function of ΔT . Thus, this work also investigates of ΔT -dependent thermal resistance which leads to a variable time constant for natural convection.

2. Simulation Set-up

This work relied on FLUENT v6.2.16 (FLUENT Version 6.2.16) to investigate numerically the phenomenon of natural convection. Gambit was used to generate a very fine grid for a cylindrical disc of fluid (40 mm diameter; 2 mm height). The Rayleigh-Bénard convection apparatus was modeled by dividing the fluid volume into 20 axial layers and 400 circumferential divisions. After importing this fine grid into FLUENT a three-dimensional simulation of unsteady flow was performed using a first order implicit scheme. The transient simulations proceeded in small time steps of 50 ms. Due to the low velocity of the simulations, pressure-based (segregated) solver was used to avoid unnecessary long calculation times. A pressure-based solution is considered sufficient for velocities in the subsonic region (Kelecy F. J., FLUENT Technical Notes TN191, 2002). The numerical simulation used a laminar viscous model, which is valid for low Rayleigh numbers. There is disagreement over the Rayleigh number values at which a turbulent model becomes necessary. However, a Rayleigh number of 50,000 is universally accepted as the minimum value requiring turbulent treatment (Jaluria Y., 1980a). All simulations in this study were well within this limit.

The properties of water used for this study were those that obtain at a temperature of 20°C (CRC handbook, 2008). A combination of various boundary conditions was chosen including a constant temperature (Dirichlet boundary condition), constant heat flux (Neumann boundary condition), convective boundary condition (Robin boundary condition), and insulated boundary condition (FLUENT Version 6.2.16).

The governing equations for natural convection flow are coupled elliptic partial differential equations, which are difficult to solve (Jaluria Y., 1980b). The partial elliptic

nature of these equations can be attributed to the inherent variation of density with temperature. To simplify the governing equations several approximations were made. The Boussinesq approximation (Boussinesq J., 1903) is one in which the density difference can be estimated as a pure temperature effect. This difference causes the flow due to an interaction between the gravitational body force and the hydrostatic pressure gradient. Boussinesq is a good approximation whenever density differences are small enough to be disregarded except when such differences appear in terms multiplied by gravitational acceleration. For liquids, Boussinesq is a particularly good approximation since the coefficient of expansion is relatively small. This approximation simplifies coupled equations of natural convection.

To model the buoyancy driven flow, this study used a Boussinesq approximation for density variation with respect to temperature. With these approximations, the energy and flow equations were solved using FLUENT. A first order upwind scheme was used for discretization of momentum and energy. The operating pressure was defined as atmospheric pressure. Pressure-velocity coupling was achieved through the SIMPLE (semi-implicit method for pressure-linked equations) algorithm (Wei et. al., 2002). The SIMPLE scheme is recommended by FLUENT for modeling natural convection and other buoyancy-driven flows. The value of convergence criterion for momentum and continuity equations were set to $1e-4$ and those for energy equation were set to $1e-6$. A convergence criterion of $1e-6$ proved difficult for 300 iterations. Hence, for momentum and continuity equations, the convergence criteria were increased to $1e-4$. This criterion was considered sufficient for these simulations.

For the post-processing of data, various surface and volume monitors were configured in FLUENT. For example, surface temperature and heat flux monitors were used to record the transient behavior of the sink side temperature and an internal energy volume monitor was used to determine the energy stored in the fluid medium.

These simulations were run on a high-performance Alienware Workstation with a 2.41GHz dual core AMD Opteron (TM) processor 280-, with 4GB of RAM. When all four processors were used in parallel, these simulations typically took between 12 and 16 hours of computer time. This computer time is a significant improvement over that required by computer with a 3.4-GHz Pentium 4 processor with 1 GB RAM which takes approximately 70 hours of computer CPU time (Usman et al., 2007b).

3. Variable Thermal Resistance for Natural Convection

To investigate the ΔT -dependency of thermal resistance for a natural convection system, a number of FLUENT simulations were performed. For conduction, thermal resistance is constant for a given geometry as long as variations in material properties with temperature are disregarded. For a constant thermal resistance, a plot of ΔT versus heat flux would be a straight line. If the resistance varied however, this linearity would not hold.

3-a. Simulation Boundary Conditions

To investigate the ΔT dependency of thermal resistance 31 simulations were run. For each one a constant heat flux boundary conditions was applied on the source side. The heat flux values were chosen such that they would cover the entire range from; pure conduction to the conduction-convection transition to the convection region. The values of heat flux used per square meter were 200, 300, 400, 500, 600, 1600, 1700, 1800, 1900,

2000, 2200, 2400, 2600, 2800, 3000, 3200, 3400, 3600, 3800, 4000, 4100, 4200, 4300, 4400, 6000, 6100, 6200, 6300, 6400, 10000, and 20000 W . On the sink side, a constant convective boundary condition ($h= 100$ W per m^2 per K, $T_{amb} = 300$ K) was applied for all runs. Side circumferential walls were perfectly insulated. Water, initially at 20°C , was chosen as a working medium.

3-b. Simulation Results Analysis

The simulations were performed to observe the transient response of the sink side temperature as it approached steady state (an asymptotic value). For each heat flux boundary condition, the steady state temperature difference between the source plate and the sink plate (ΔT) was calculated. Thermal resistance (R_{Th}) was determined for each heat flux value (q'') using the basic steady-state circuit analogy $R = \frac{V}{I}$ or $R_{Th} = \frac{\Delta T}{q''}$.

Figure 3 shows the variation of heat flux (q'') with respect to ΔT .

The thermal conductivity of fluid (i.e., pure conduction) is always less than the heat transfer coefficient for natural or forced convection. Thermal resistance is inversely proportional to the thermal conductivity of fluid in case of conduction, whereas it is inversely proportional to the heat transfer coefficient in case of natural convection. Hence, thermal resistance, R_{Th} , for natural convection is smaller than that for conduction.

It is evident from the figure 3 that there are two distinct regions. For small values of ΔT (i.e., during conduction before the onset of natural convection) the slope is linear. This ohmic behavior is the response of a pure conductive system. However, at just above a ΔT of 7°C nonlinear behavior began due to onset of convection.

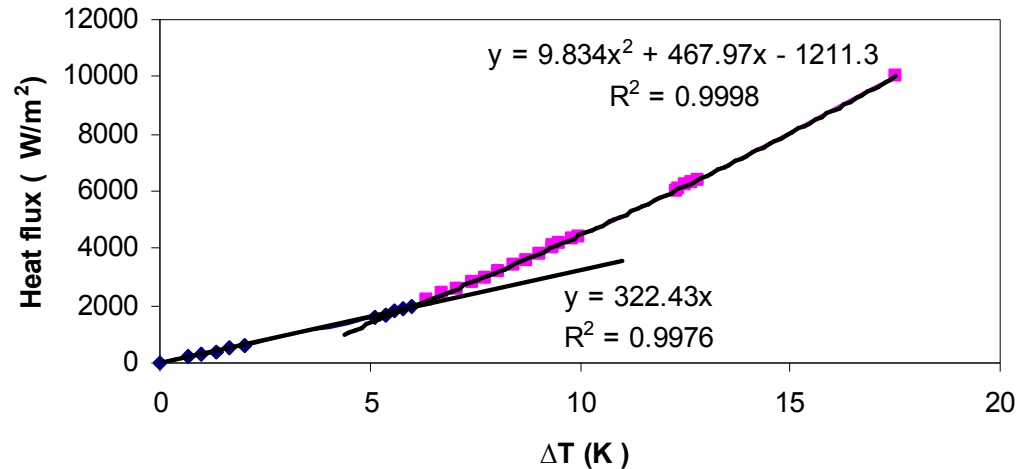

Fig.3 Heat flux variation with respect to ΔT

Figure 3 clearly shows that for natural convection the slope changes continuously (i.e. increases). Thus, thermal resistance for natural convection continuously decreases with increasing ΔT . This obvious result is important for the extension of the RC circuit analogy for natural convection. Thermal resistance of the system was calculated by taking the quotient of $\frac{\Delta T}{q''}$, or in electrical terminology $R = \frac{V}{I}$. Thermal resistance was plotted as a function of ΔT . As shown in figure 4, thermal resistance remains constant until ΔT reaches approximately 7°C , then drops rapidly. This drop in thermal resistance appears to be an exponential or polynomial function; however, further research is needed to determine the dependency of thermal resistance on ΔT . This dependency can be expected to include the fluid's physical properties as well as its flow characteristics.

It is reassuring that in electrical circuits, the concept of a voltage-dependent resistor (VDR) is well established (see for example Nagel and Rohrer 1971 or Kundert, ,1998). These techniques can be used to model the variable thermal resistance of natural convection.

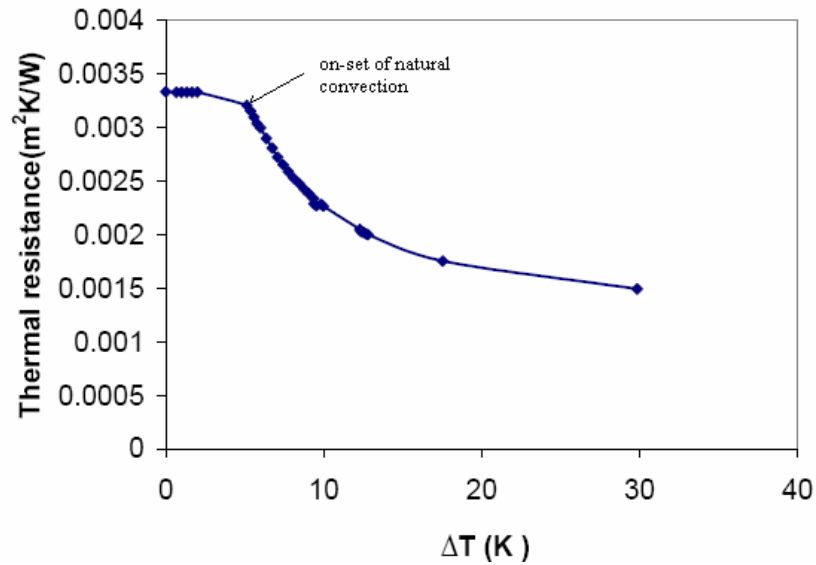

Fig.4 Thermal Resistance Variation with Temperature Difference (ΔT)

All simulations used the same geometry and the fluid properties were also kept constant. Thus as is evident in figure 4, thermal resistance for natural convection is a nonlinear function of ΔT , whereas for conduction it is constant and independent of ΔT . Figure 5 represents thermal resistance variation with the Rayleigh number. It clearly demonstrates that at higher Rayleigh numbers the change in thermal resistance with ΔT is lower than that at lower values of the Rayleigh number. This aspect of the results requires further investigation. The onset of convection was observed at a Rayleigh number lower than the critical Rayleigh number (i.e., 1708 for two infinitely long parallel plates). This difference can be attributed to the fact that the simulation geometry was finite and the interference from the circumferential wall leads to a lower value of the critical Rayleigh number (i.e., the wall effect).

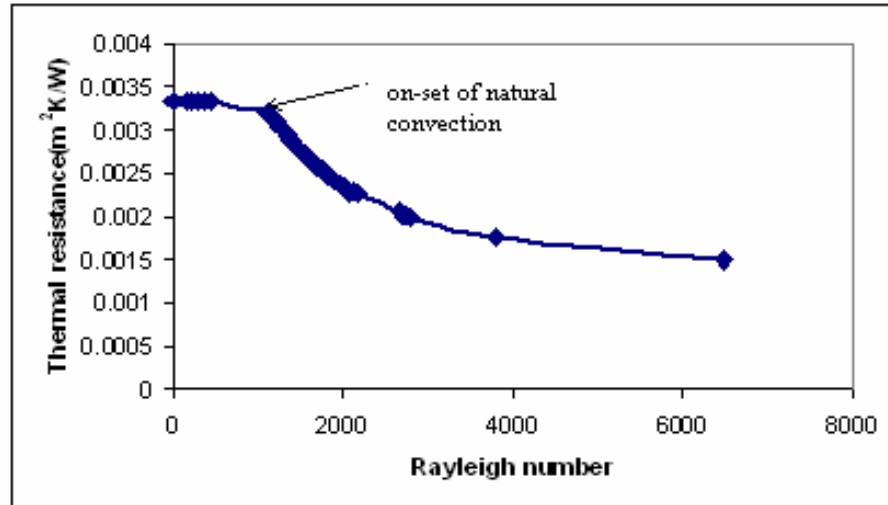

Fig.5 Thermal Resistance Variation with Rayleigh Number

4. Kinetic Energy Capacitance

In electrical circuits, the capacitor stores the electrical charge; therefore, voltage builds up across the capacitor (Bryant, 2006). Similarly, in the case of heat transfer systems involving pure conduction, heat is stored in the form of internal energy, which is also referred to as the thermal capacitance of the system. The transient behavior of a thermal system depends primarily on the systems energy storage capacity.

In the case of systems involving natural convection, in addition to the energy stored in internal energy form (i.e., thermal capacitance), some energy is also used to set the fluid in motion. This fluid motion is induced by buoyancy resulting from body forces acting on density gradients, which in turn arise from temperature gradients in the fluid (Kays et al., 2005.) As per the first law of thermodynamics, the energy used to set the fluid in motion is stored in the form of kinetic energy. Thus a natural convection heat transfer system has an additional energy storage mechanism (i.e., kinetic energy capacitance as well as thermal capacitance).

4-a. Simulation Boundary Conditions

Additional simulations performed using the fluid geometry/mesh created for earlier simulations representing Rayleigh-Bernard convection. On the source side, a constant heat flux boundary condition was applied. Values of heat flux were chosen such that there would be natural convection in all cases. On the sink side, a convective boundary condition was applied ($h=100\text{W/m}^2\text{K}$, $T_{\text{amb}}=300\text{K}$ for all runs). The side walls were perfectly insulated. At the start of the simulation, the fluid was assumed to be at rest at 300K; thus, its initial energy content was equal only to the internal energy. FLUENT's surface monitors were configured to measure the time response of heat flux on the sink side.

4-b. Kinetic Energy Finding Technique

To determine the portion of kinetic energy stored, a constant heat flux was applied on the source side, and the sink side heat flux was monitored using FLUENT's surface monitors. The sink side heat flux was plotted as a function of simulation time. It was found to approach the source side heat flux asymptotically. The time integral area between the two curves (i.e., source-side and sink-side heat flux) was estimated using Origin Pro 8. This area represents the total energy stored in the system. The conduction and convection systems were compared to determine the kinetic energy stored in the system.

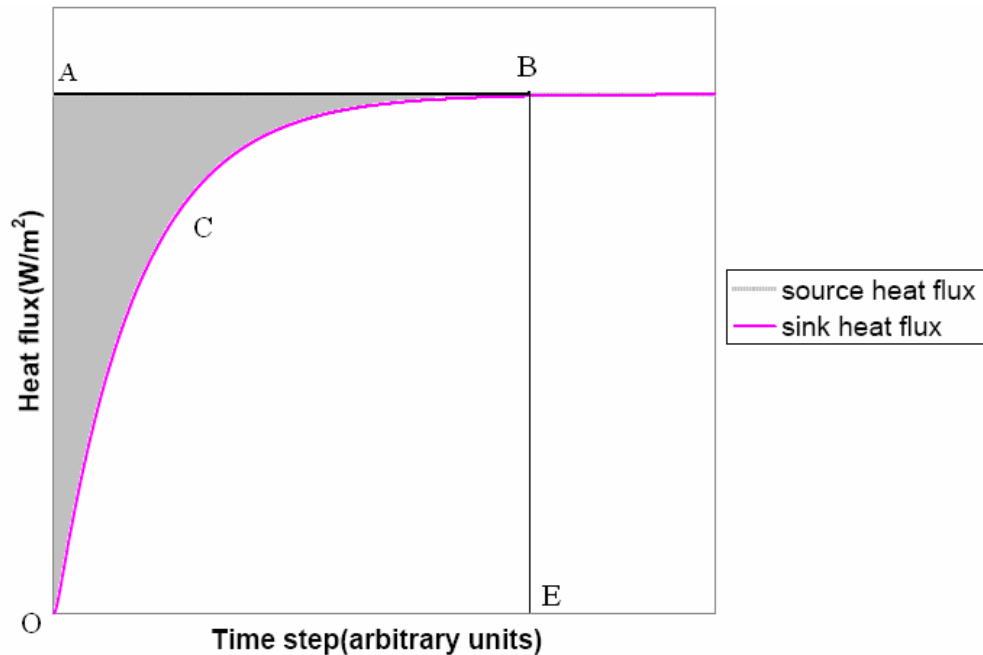

Fig. 6 Heat Flux Variation during Transient

Figures 6 represent the time response of the heat flux on the source and sink sides. Thus the area under curve OABE represents heat input to the Rayleigh-Bernard convection apparatus, and area under curve OCBE represents heat coming out of the Rayleigh-Bernard convection apparatus. Thus the area OCBAO represents the change in the energy of fluid. As mentioned above this change consists of the change in its internal energy and that associated with setting up the fluid motion. Since the fluid was assumed to be at rest initially, the part of the energy change associated with fluid motion represents the energy stored in the form of Kinetic energy. Fig. 7 plots the kinetic energy stored per kilogram of working fluid versus the Rayleigh number.

Figure 7 clearly shows that natural convection involves an additional energy storage mechanism, i.e., kinetic energy capacitance. The amount of kinetic energy stored varies almost linearly with the Rayleigh number. This linear relationship confirms that for a given geometry, the square of the characteristic velocity is a function of the

temperature difference between the source and the sink (Jaluria , 1980b). At a Rayleigh number approximately equal to 1500, the kinetic energy decreases to zero, which indicates that pure conduction occurs below 1500. This lower value of critical Rayleigh number (as compared to 1708 for two infinitely long parallel plates) can be attributed to the wall effect. Further investigation is needed to determine the impact of geometrical parameters on kinetic energy stored in fluid. Also, the impact of this additional capacitance on the time constant of natural convection during transients is potentially significant, particularly in liquid metal cooled reactors, and would require further investigation.

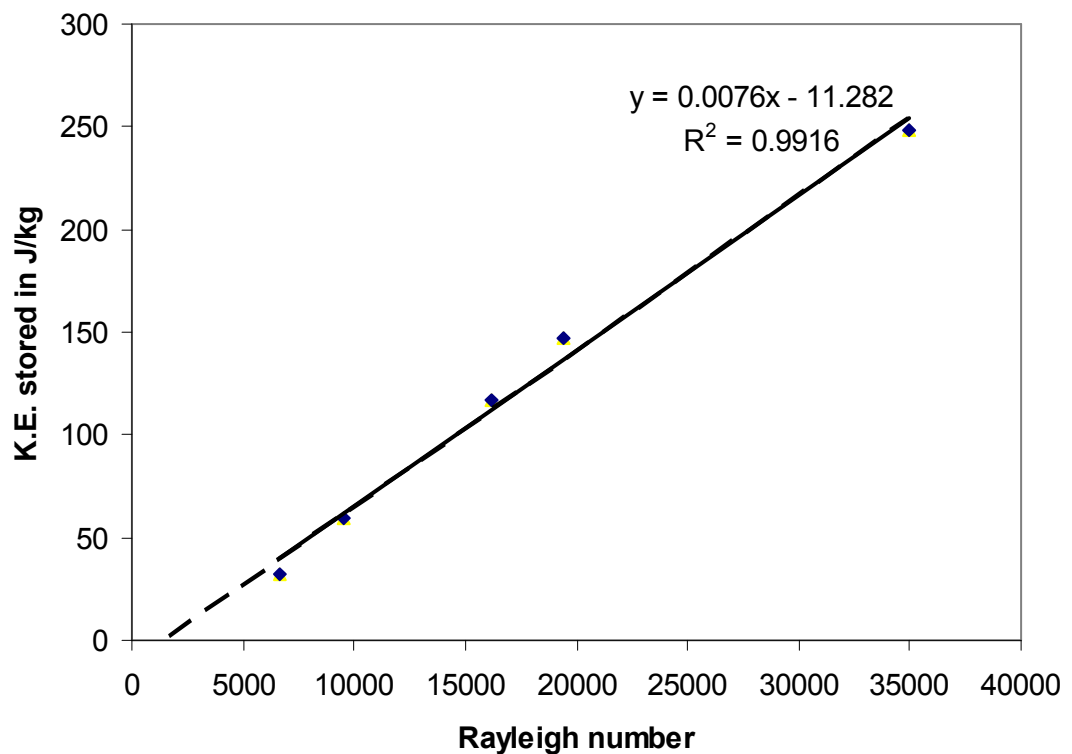

Fig. 7 Variation in Kinetic Energy Stored with Rayleigh Number

5. Conclusion

Based on the extension of an electrical analogy, this work has drawn a revised equivalent circuit for natural convection. The new circuit resembles an equivalent RC circuit, however, the resistance is shown as a combination of two parallel resistances. One resistance is fixed representing the thermal resistance for conductive heat transfer. Parallel to this, a variable resistance is added for convective heat transfer, representing two parallel paths for heat transfer. The conductive resistance depends solely on fluid properties and is therefore fixed. The convective resistance depends on the fluid properties and conditions; therefore, it varies with the Rayleigh number. Thus when the Rayleigh number is small, the convective resistance will be infinite and conduction will be represented as a limiting case of convective heat transfer.

Likewise, an additional capacitor has been added to the equivalent circuit because natural convection stores some energy in the form of fluid kinetic energy. Therefore, in addition to the energy stored in the form of heat or fluid internal energy, the system stores energy in the form of kinetic energy of the fluid. The literature has not addressed this aspect of natural convection.

Total thermal resistance for natural convection depends upon the temperature difference between the source and the sink along with fluid properties and geometrical parameters. In an electrical circuit, there is a voltage-dependent resistor analogous to the variable behavior of thermal resistance of natural convection. The results presented here show that thermal resistance for natural convection decreases with an increase in ΔT , which is directly proportional to the dimensionless Rayleigh number. The exact dependency of the resistance on the temperature difference requires further investigation.

Stored kinetic energy is found to be a linear function of the Rayleigh number for a given working fluid. It is evident from the graph in figure 7 that kinetic energy is zero for a Rayleigh number value somewhere around 1500. Below this Rayleigh number, kinetic energy is zero, which essentially represents a conduction region. For the geometry investigated in this research, kinetic energy is a very small fraction of the total energy stored in the system. However, since stored kinetic energy is related to the Rayleigh number (which in turn is proportional to cubed characteristic length) kinetic energy storage can be very significant for certain geometries. This additional capacitance affects the time constant and hence the transient response of a natural convection system.

Additional kinetic energy capacitance and the variable nature of thermal resistance must be considered when representing natural convection by an equivalent RC circuit. Standard tools are available for electrical circuit analysis (e.g., the simulation program for integrated circuit emphasis, or SPICE) with variable resistance (Kundert 1998 and Nagel et al., 1971). These tools can be adopted for analysis of natural convection using an equivalent analogous circuit. This analogy can be used as an inexpensive modeling and analysis tool for natural convection.

Acknowledgements

This work was made possible through DOE NEER grant 2006-ID-1002. The authors sincerely appreciate their support. They would also like to thank Mr. Randy Haffer of Missouri University of Science and Technology IT department for facilitating computer simulations.

NOMENCLATURE

Symbol	Description	Units
C	Electrical Capacitance	F
R	Electrical Resistance	Ω
V_C	Input Voltage	V
V_R	Output Voltage	V
T_{source}	Temperature at Source Side	K
T_{sink}	Temperature at Sink Side	K
k	Thermal Conductivity	$W.m^{-1}.K^{-1}$
q''	Heat Flux	W/m^2
α	Thermal Diffusivity	$m^2.s^{-1}$
ν	Kinematic Viscosity	$m^2.s^{-1}$
ρ	Density	$Kg.m^{-3}$
τ	Characteristic Time Constant	s
β	Coefficient of Volumetric Expansion	1/K
ΔT	Temperature Difference between Source and Sink	K

REFERENCES

- Aqrawal, A.K. and Guppy, J.G. (Eds), 1981, Decay Heat Removal and Natural Convection in Fast Breeder Reactors, Hemisphere Publishing Corp., Washington, DC.
- Bau, H., 1999, Control of Marangoni-Bénard Convection, International Journal of Heat and Mass Transfer, 42, pp.1327-1341.
- Bejan, A., 2004, Convection Heat Transfer, 3rd Edition, John Wiley and Sons, New York, Chapter V, pp.185-188.
- Boussinesq J., 1903, Théorie analytique de la chaleur Volume 2, Gauthier-Villars, Paris.
- Bryant, J., 2006, Circuit Analysis Essentials: A Signal Processing Approach, Thomson Delmar Learning, New York, pp.253-257.
- Chin, Y.K., Nordlund, E., Staton, D.A., 2003, Thermal Analysis - Lumped Circuit Model and Finite Element Analysis, Sixth International Power Engineering Conference (IPEC2003), pp. 952 - 957, Singapore, 27 - 29 November, 2003.
- Chin, Y.K., Staton, D.A., 2004, Transient Thermal Analysis using both Lumped-Circuit Approach and Finite Element Method of a Permanent Magnet Traction Motor, IEEE AFRICON, pp. 1027 - 1035, Gaborone, Botswana, September 2004.
- CRC Handbook of chemistry and physics-2008 edition-Section VI-4.
- Duffey, R. B., and Hedges, K., 1999, Future CANDU Reactor Development. Proc. 7th Int. Conf. Nuclear Engineering (ICONE-7), Tokyo, Japan, April 19–23, ICONE-7459, Japan Society of Mechanical Engineers.
- FEMLAB v2.30, Comsol AB (<http://www.comsol.com/press/news/article/243/>).
- FLUENT Incorporated Network Services; www.FLUENT.com (Version 6.2.16)
- INEEL, 2001. RELAP5-3D© code manual volume I: code structure, system models, and solution methods, INEEL-EXT-98-00834. Idaho National Engineering and Environmental Laboratory, Idaho Falls, Idaho.
- Jaluria Y., 1980a, Natural convection heat and mass transfer, Pergamon Press, Chapter 7, pp. 222-229.
- Jaluria Y., 1980b, Natural convection heat and mass transfer, Pergamon Press, Chapter 2, pp. 19-22.
- Kays, W. M., Crawford, M. E., and Weigand, B., 2005, Convective Heat and Mass Transfer, McGraw Hill Higher education, New York, p. 367.
- Kelecly F. J., FLUENT Technical Notes-TN191, A Benchmark Calculation of Natural Convection in a Differentially- Heated Cubical Enclosure, 2002.
- Kundert, K.S., 1998, The Designer's Guide to SPICE and SPECTRE, Kluwer. Academic Publishers, Boston, pp-224-226.
- Mackay, F. J., Apostolakis, G. E., and Hejzlar P., 2008, Incorporating reliability analysis into the design of passive cooling systems with an application to a gas-cooled reactor, Nuclear Engineering and Design, Vol.238(1), pp. 217-228 .
- Motor-CAD v1.6(14), Motor Design Ltd (<http://www.motor-design.com/motorcad.php>).
- Staton, D., 2000, Permanent Magnet Motor CAD - Thermal Design Aspects, UK Magnetics Society Seminar 'Developments in the manufacture and use of permanent magnets', Austin Court, Birmingham, UK.
- Nagel, L. and Rohrer, R., 1971, Computer analysis of nonlinear circuits, excluding radiation (CANCER), IEEE Journal of Solid-State Circuits, Vol. 6(4), pp. 166-182.

- Paschkis, V., and Baker, H.D., 1942, A Method for Determining Unsteady-State Heat transfer by Means of an Electrical Analogy, *Trans. ASME*, 64, New York, N.Y., 105-112.
- Rohsenow, W.M. and Hartnett, J.P., 1973, *Handbook of Heat Transfer*, McGraw-Hill, New York, 3.23-3.24.
- Scheuerer, M., Heitsch, M., Menter, F., Egorov, Y., Toth, I., Bestion, D., Pigny, S., Paillere, H., Martin, A., Boucker, M., Krepper, E., Willemsen, S., Muhlbauer, P., Andreani, M., Smith, B., Karlsson, R., Henriksson, M., Hemstrom, Karppinen, I., and Kimber, G., 2005, Evaluation of computational fluid dynamic methods for reactor safety analysis (ECORA), *Nuclear Engineering and Design* Vol. 235(2-4), 359–368.
- Sienicki, J.J. and Moisseytsev, A.V., 2005. SSTAR Lead-Cooled, Small Modular Fast Reactor for Deployment at Remote Sites - System Thermal Hydraulic Development, *International Congress on Advances in Nuclear Power Plants*, Seoul, KOREA, May 15-19, Paper 5426.
- Sinha R.K. and Kakodkar, A., 2006, Design and Development of the AHWR—the Indian Thorium Fuelled Innovative Nuclear Reactor, *Nuclear Engineering and Design*, Vol. 236(7-8), 683-700.
- Usman, S., Abdallah, S., Hawwari, M., Scarangella, M., and Shoaib, L., 2007a, Integrator Circuit as an Analogy for Convection, *Nuclear Technology*, 157, 65-73.
- Usman, S., Mohammad, B.S., and Abdallah, S., 2007b, Natural Convection's Transient Behavior, *Nuclear Technology*, 159, 310-318.
- Wei J., Yu B., Wang H. S. and Tao W. Q., 2002, Numerical Study of Simultaneous Natural Convection Heat Transfer from Both Surfaces of a Uniformly Heated Thin Plate With Arbitrary Inclination, *Heat and Mass Transfer* Vol. 38, pp.309-317.

VITA

Vaibhav Bhausahab Khane is a M.S. student in Nuclear Engineering at Missouri University of Science and Technology in Rolla, Missouri. He was born in Kolhapur, India, on April 17, 1981. In February 2003, he received his B.E. in Mechanical engineering from the Shivaji University. He joined one year Orientation course for Engineering Graduates and Science post-graduates (OCES-2004 batch) in Nuclear engineering in September 2004. After successful completion of training, he joined as a Scientific Officer-C to Nuclear Power Corporation of India Ltd. He worked with NPCIL for nearly three years as a system commissioning engineer for TAPP 3and4, as a main plant operation engineer for KGS 1and2.

Vaibhav Khane has been a student member of the American Nuclear Society (ANS) since 2007. Also he has been a student member of the American Society for Mechanical Engineers (ASME) since 2007. He was inducted into Alpha Nu Sigma in 2009.